



W4 (EA/SA/INTA)

Instructions for Use



Original instructions for use
Before using the machine read the instructions for use.



Additional online content

Tap, click or scan the QR code to access additional online resources.

There are video tutorials to help you operate your W4.



jura.com/support-W4

Contents

1	Control elements	3
2	For your safety	4
	Comply with the instructions for use.....	4
	Proper use	4
	User limitations	4
	Use by children.....	4
	What to do in the event of damage.....	4
	Preventing damage.....	5
	Danger of electric shock	5
	Danger of burns, scalding and injury.....	5
3	Preparing and using for the first time	6
	Setting up the machine	6
	Filling the bean container.....	6
	Determining the water hardness	6
	First-time use.....	6
	Managing your W4 – the JURA Cockpit	7
4	Preparation	8
	Espresso and coffee.....	8
	Americano and lungo	8
	Hot water.....	9
	Ground coffee.....	9
	Adjusting the grinder.....	10
	Adjusting the product settings.....	10
5	Daily operation	10
	Switching the machine on and off.....	10
	Filling the water tank.....	10
	Maintenance actions	11
6	Machine settings	11
7	Maintenance	12
	Rinsing the machine.....	12
	Inserting/changing the filter	12
	Cleaning the machine	13
	Descaling the machine	14
	Descaling the water tank.....	15
	Cleaning the bean container.....	15
8	Display messages	16
9	Troubleshooting	16
10	Transport and environmentally friendly disposal	17
	Transport / Emptying the system.....	17
	Disposal.....	17
11	Technical data	17
12	Index	18
13	JURA contact details / Legal information	19

1 Control elements

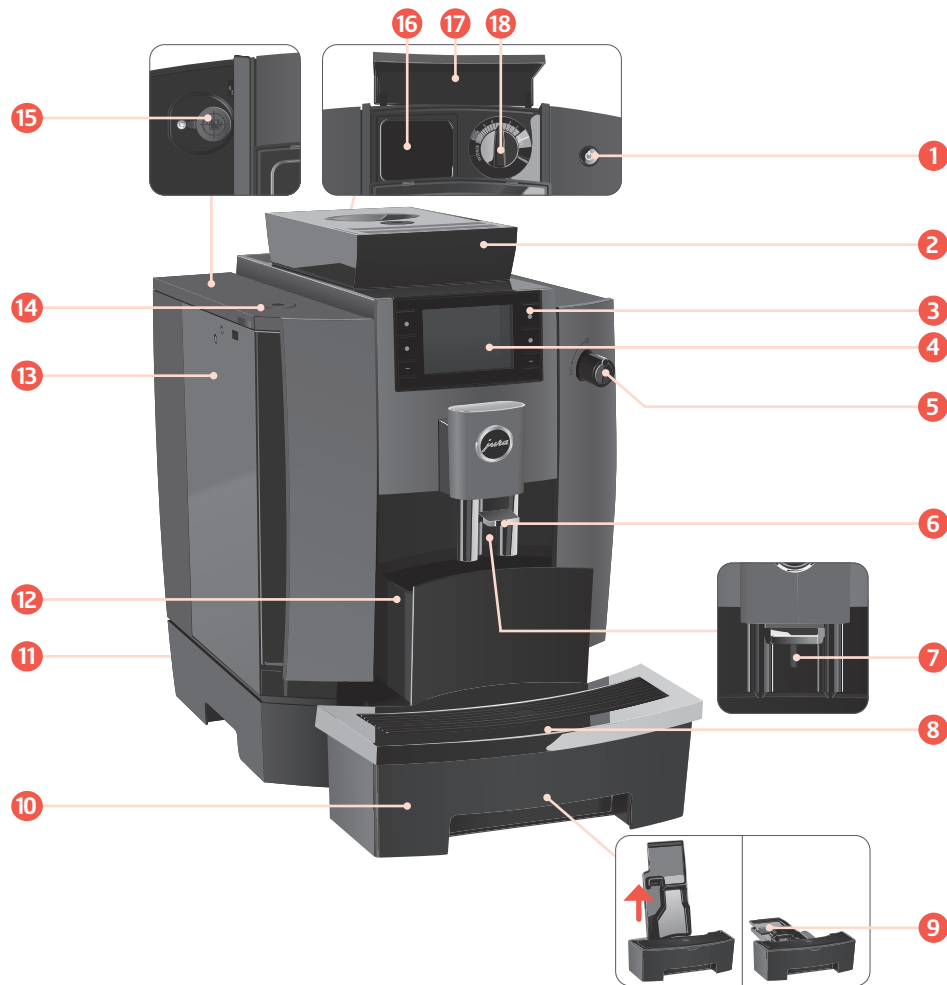

- 1 On/Off button
- 2 Bean container with aroma preservation cover (lockable)
- 3 Multi-function buttons (button function depends on what is shown in the display)
- 4 Display
- 5 Switch for hot water preparation
- 6 Height-adjustable coffee spout
- 7 Hot-water spout
- 8 Cup grille with aperture
- 9 Insert for drip tray
- 10 Drip tray
- 11 Mains cable (permanently connected or plug-in) (back of the machine)
- 12 Coffee grounds container
- 13 Water tank
- 14 Water tank cover (lockable)
- 15 Service socket for an optional JURA Connector
- 16 Filler funnel for ground coffee (removable)
- 17 Filler funnel cover
- 18 Grinder adjustment switch
- 19 Measuring spoon for ground coffee
- 20 Key for aroma preservation cover and water tank cover

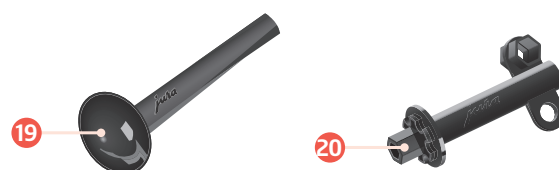



2 For your safety

Comply with the instructions for use

Before using the machine, read these instructions for use thoroughly and completely and comply with the instructions they contain. Keep these instructions for use close to the machine and pass them on to the next user.

Failure to observe the instructions for use may result in serious injuries or damage to property. Safety information is therefore indicated as follows:

 WARNING	Indicates circumstances that may result in serious injuries or death.
 CAUTION	Indicates circumstances that may result in minor injuries.
CAUTION	Indicates circumstances that may result in damage to property.

Proper use

This machine is intended for use by specialist or trained staff in businesses, light industry and agricultural facilities or for commercial use by non-professionals. It should only be used for coffee preparation and to heat water. Use for any other purpose will be deemed improper.

User limitations

People, including children, who do not have the

- physical, sensory or mental capabilities to use the coffee machine safely,
 - or lack the necessary experience or knowledge to use the machine safely,
- must be supervised by a responsible person when using it, or must be instructed in how to use it correctly.

When using the CLARIS Pro Smart+ filter cartridge or a JURA Connector, wireless connections are established. Specific details on the frequency band used and the maximum transmission power can be found in the '11 Technical data' section.

Use by children

Children must be able to recognise and understand the potential dangers arising from incorrect use:

- Keep **children under the age of 8** away from the machine, or supervise them constantly.
- **Children aged 8 and over** may only operate the machine without supervision if they have been instructed in how to use it safely.
- Children may not clean or service the machine unless supervised by a responsible person.
- Do not allow children to play with the machine.

What to do in the event of damage

Never use a damaged machine or mains cable. This could result in fatal electric shock.

- In the event of signs of damage, disconnect the machine from the mains. To do this, first switch the W4 off with the On/Off button . Only then should you remove the mains plug from the power socket.
- Replace a damaged **plug-in mains cable** with an original JURA mains cable. Unsuitable mains cables may result in consequential damage.
- Only permit authorised JURA service centres to carry out **repairs to the machine** and the **permanently connected mains cable**. Unsuitable repairs may result in consequential damage.

Preventing damage

To avoid damage to the machine and the mains cable:

- The W4 must not be placed in a cabinet when in use.
- Do not use the W4 and the mains cable near hot surfaces.
- Do not allow the mains cable to rub against sharp edges and ensure that it does not become trapped.
- Never allow the mains cable to loosely hang down. The mains cable could pose a tripping hazard or become damaged.
- Protect the W4 from weather and direct sunlight.
- Only connect the W4 to a mains voltage corresponding to that stated on the rating plate. The rating plate is located on the underside.
- Connect the W4 directly to a domestic power socket. Using multi-socket adapters or extension cords may cause overheating.
- The surface of the heating element and outer enclosure remains hot after use and the outside of the appliance may retain heat.
- Do not use alkaline or alcohol-based cleaning agents; only use mild cleaning agents and a soft cloth.
- Do not use any coffee beans treated with additives or caramelised coffee beans.
- Only fill the water tank with fresh, cold, non-carbonated water.
- Switch the machine off with the On/Off button  if you are going to be absent for a longer period of time and remove the mains plug from the power socket.
- Only use original JURA maintenance products. Use of products that are not explicitly recommended by JURA could damage your W4.

Danger of electric shock

Water conducts electricity. Do not bring water and electricity into contact with one another:

- Never touch the mains plug with wet hands.
- Do not immerse the W4 and/or mains cable in water.
- Do not put the W4 or any individual parts in the dishwasher.
- Before cleaning, switch the W4 off with the On/Off button . Always wipe the W4 with a damp cloth rather than a wet one, and protect it from prolonged exposure to water splash. The W4 must not be cleaned with a jet of water.
- The W4 is not suitable for installation on a surface where a jet of water can be used.

Danger of burns, scalding and injury

- Do not touch the spouts during operation. Use the handles provided.
- Optionally, your W4 can be remotely operated using mobile devices. When preparing a product or initiating a maintenance programme, make sure that other people are not put at risk – for example, through contact with the spouts.

3 Preparing and using for the first time

Setting up the machine

- ▶ Choose a spot for your W4 which protects the machine against overheating. Ensure that the ventilation slots are not covered.

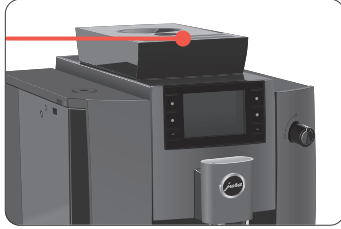

- ▶ Place the W4 on a horizontal surface that is not sensitive to water (minimum height of 80 cm).

Filling the bean container

The aroma preservation cover of the bean container is lockable (spanner supplied as standard).



CAUTION

Coffee beans which have been treated with additives (e.g. sugar), ground coffee or freeze-dried coffee will damage the grinder.

- ▶ Only use roasted, untreated coffee beans to fill the bean container.

- ▶ Remove the aroma preservation cover.
- ▶ Fill the bean container with coffee beans and close the aroma preservation cover.

Determining the water hardness

When you use the machine for the first time, you must set the water hardness. If you know the hardness of your water, go straight to the next section. If you do not know the water hardness, you can find this out first:

- ▶ Hold the Aquadur® test strip supplied under running water for one second. Shake off the water.
- ▶ Wait for about 1 minute.
- ▶ You will then be able to read the degree of water hardness from the discolouration of the Aquadur® test strip and the description on the packaging.

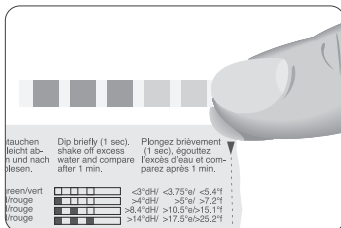

First-time use

⚠ WARNING

If the machine is operated with a defective mains cable, there is a danger of potentially fatal electric shock.

- ▶ Never use a machine which is damaged or has a defective mains cable.

CAUTION

Milk, sparkling mineral water or other liquids can damage the water tank or the machine.

- ▶ Only fill the water tank with fresh, cold water.

Precondition: The bean container has been filled.

- ▶ For machines with a **plug-in** mains cable: Connect the mains cable to the machine.
- ▶ Insert the mains plug into a power socket.
- ▶ Press the On/Off button  to switch the W4 on.
'Sprachauswahl'
- ▶ Press the > or < button until the desired language is displayed, e.g. 'English'.
- ▶ Press the 'Save' button.
'Water hardness'



i Please refer to the section above for a description of how to determine the water hardness.

- ▶ Press the > or < button to change the setting for the water hardness.
- ▶ Press the 'Save' button.
'Filter operation' / 'Insert filter'
- ▶ Remove the water tank and rinse it with cold water.
- ▶ Open the filter holder.
- ▶ Insert the CLARIS Pro Smart+ filter cartridge into the water tank, exerting slight pressure.



- ▶ Close the filter holder. It will click into place audibly.
- ▶ Fill the water tank with fresh, cold water and reinsert the tank.





i The machine automatically detects that you have just inserted the filter cartridge.

- 'Open switch'
- ▶ Turn the switch to the  position.
'Filter is being rinsed', water flows out of the hot-water spout.
'Close switch'
- ▶ Turn the switch to the  position.
'System is filling', water flows out of the hot-water spout.
'Machine is heating'
'Machine is rinsing', water flows out of the coffee spout.
The start screen is displayed. Your W4 is ready for use.

Managing your W4 – the JURA Cockpit

The **JURA Cockpit** allows you to manage your W4. Press the > button for **approx. 2 seconds** to enter the JURA Cockpit.



Symbol	Meaning
	'Maintenance' area (blue)
	'Machine settings' area (green)
	Product counter, day counter, maintenance counter
	Filter mode

4 Preparation

Specialities:

Page ● ○	
'Espresso'	'Americano'
'Coffee'	'Hot water'
Page ○ ●	
'Special coffee'	'Lungo'
'Espresso doppio'	'Hot water for green tea'

Basic information about preparing drinks:

Aim	What to do
Change the coffee strength of a single product	Press the < or > button during grinding
Change the amount for a single product	Press the < or > button during preparation
Permanently save the amount for a single product	Press 'Save' straight after preparation
Change the amount, coffee strength and temperature for any given product permanently	Press the button for a product for two seconds and configure the desired settings in 'Product settings'
Display more products	Press the > button to display the next product page
Prepare two speciality coffees (for coffee and espresso)	Press the preparation button twice within two seconds
Stop preparation	Press the X button

Coffee tastes best served hot. A cold porcelain cup cools the beverage – and impairs the taste. We therefore recommend prewarming the cups. You can purchase a JURA cup warmer from your specialised dealer.

Espresso and coffee

Example: Coffee

- Place a cup under the coffee spout.



- Press the 'Coffee' button (on page ● ○).
The preset amount of water for coffee flows into the cup.

i Espresso and coffee can also be prepared as a **double product**. To do this, press the 'Espresso' or 'Coffee' button twice.

Americano and lungo

For the americano and lungo, the W4 blends the coffee with hot water using a special preparation method. This results in a full-bodied speciality coffee which is particularly easy to digest. You can change the amount of this additional water (see chapter 4 'Preparation – Adjusting the product settings').

Hot water

The W4 allows you to prepare different variants of hot water:

- 'Hot water' (on page ● ○)
- 'Hot water for green tea' (on page ○ ●)

⚠ CAUTION

There is a danger of scalding from hot water splashes.

- Avoid direct contact with the skin.

Example: Hot water

- Place a cup under the hot-water spout.



- Press the 'Hot water' button (on page ● ○).
'Open switch'
- Turn the switch to the ☰ position.
The preset amount of water flows into the cup.
'Close switch'
- Turn the switch to the ⊙ position.

Ground coffee

You can choose to use a second coffee variety, for example decaffeinated coffee, with the filter funnel for ground coffee.

Basic information about ground coffee:

- Never add more than two level measuring spoons of ground coffee.
- Use ground coffee which is not ground too finely. Very fine coffee can block up the system so that the coffee only comes out in drips.
- If you did not fill the machine with a sufficient amount of ground coffee, 'Not enough ground coffee' is displayed and the W4 stops the operation.
- The desired speciality coffee must be prepared within approximately one minute after filling with the ground coffee. Otherwise the W4 stops the operation and is once more ready for use.
- All speciality coffees with ground coffee are always prepared following the same model.

Example: Espresso with ground coffee

- Place an espresso cup under the coffee spout.
- Press the ☑ button to open the Speciality Selection.
- Press the 'Ground coffee' ☕ button.
- Press the ✓ button.
- Press the 'Espresso' button (on page ● ○).
'Please add ground coffee'
- Open the cover of the filler funnel for ground coffee.

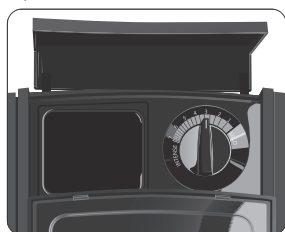

- Add the desired amount of ground coffee to the filler funnel (max. 2 level measuring spoons).

i The amount of ground coffee determines the intensity and aroma of the beverage, so you can adjust it to your personal preferences.

- Close the cover of the filler funnel.
- Press the 'Next' button.
The preset amount of water for espresso flows into the cup.

5 Daily operation

Adjusting the grinder

You can adjust the grinder to suit the degree of roast of your coffee.

The consistency of grind is correct if the coffee flows regularly from the coffee spout. In addition a fine, thick crema forms.

- ▶ Open the cover of the filler funnel for ground coffee.
- ▶ Turn the grinder adjustment switch to the desired position.

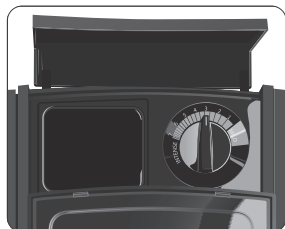

- ▶ Close the filler funnel cover.

Adjusting the product settings

Press a product button for **about two seconds** to view the list of settings:

- 'Product settings': Specify individual settings such as coffee strength, amount of water, etc.
- 'Reposition the product': Replace products on the start screen

Permanent settings in programming mode always follow the same model.

Example: Proceed as follows to change the coffee strength for one coffee.

- ▶ Press the 'Coffee' button for **about 2 seconds**.
- ▶ Press 'Product settings'.
'Coffee strength'

i Different settings will be available depending on the selected product: Press the ◀ or ▶ button to navigate the various settings.

- ▶ Press the > or < button to change the setting.
- ▶ Press the 'Save' button.
- ▶ Press X to return to the start screen.

5 Daily operation

Switching the machine on and off

- ▶ Place a receptacle under the coffee spout.



- ▶ Press the On/Off button .
- 'Machine is rinsing'
- Your W4 is switched on or off.

i When the machine is switched off, the system is only rinsed if a speciality coffee has been prepared.

Filling the water tank

Daily maintenance of the machine and hygiene when handling milk, coffee and water are key to a perfect coffee result in the cup every time. You should therefore change the water **daily**.

CAUTION

Milk, sparkling mineral water or other liquids can damage the water tank or the machine.

- ▶ Only fill the water tank with fresh, cold water.

You can lock the water tank cover with the spanner provided.

- Open the water tank cover.
- Remove the water tank and rinse it with cold water.
- Fill the water tank with fresh, cold water and reinsert the tank.
- Close the water tank cover.

Maintenance actions

Optimal coffee quality depends on many factors. One important prerequisite is regular maintenance of your W4. Carry out the following steps:

Maintenance action	Daily	If necessary	Note
Empty the drip tray and coffee grounds container and rinse with warm water (The insert for the drip tray, including the drip tray itself, and the coffee grounds container are dishwasher-safe)	▪		Always empty the coffee grounds container when the machine is switched on. This is the only way of resetting the coffee grounds counter.
Rinse the water tank	▪		
Wipe the surface of the machine with a clean, soft, damp cloth (e.g. microfibre cloth)	▪		
Clean the inside of the water tank with a brush		▪	
Clean the top and bottom of the cup grille		▪	
Thoroughly clean the drip tray and coffee grounds container		▪	

i You will find more information about the maintenance of your W4 in the 'Maintenance' area  in the programme item 'Information'.

6 Machine settings

Press the > button for **approx. 2 seconds** to enter the JURA Cockpit. The following settings can be saved in 'Machine Settings' :

Programme item	Explanation
Page ● ○ ○	
'Switch off after'	To save energy, the switch-off time is set to 30 minutes ex-works. Possible settings: Switch-off after 15 minutes, 30 minutes or 1-9 hours after the last action on the machine If you extend the switch-off time, you therefore accept a high energy consumption. Energy consumption of the W4 when switched off: 0 Watt.
'Water hardness'	Set the hardness of the water used (1 °dH to 30 °dH) to prevent limescale building up in your machine
'Save energy'	Deactivate/activate energy-saving mode
'Units'	Set the unit for the amount of water (ml or oz)
Page ○ ● ○	
'Choose language'	Set language
'Empty system'	Empty the system to protect the W4 from frost damage during transport (see chapter 5 'Daily operation – Filling the water tank').
'Factory setting'	Reset your W4 to factory settings (the machine then switches off)
'Version'	View software version
Page ○ ○ ●	
'Lock/enable'	Blocking and releasing individual products
'Product settings'	Define whether the permanent product settings can be changed or not
'One-off settings'	▸ Specify whether or not to allow one-off settings during preparation.
'Accessories' (only displayed if JURA Connector is being used)	Sub-menu(s) when using JURA Wi-Fi Connect: 'Wi-Fi connection' JURA Payment Connect: 'QR code' / 'Reset Payment Connect' JURA MDB Connect: 'Incasso'

7 Maintenance

Basic information about maintenance:

- If a maintenance programme is pending, this is indicated by an additional red circle on the start screen (●○○). Press the > button for **approx. 2 seconds** to enter the JURA Cockpit. You can manage the maintenance of your W4 in the ⚙️ section.
- In the Cockpit of your W4, maintenance programmes that need to be carried out are shown in the form of messages with red backgrounds. Press the button that corresponds to the message to go straight to the maintenance programme. Maintenance programmes that are due imminently are indicated on your W4 by means of a bar display within the message.
- Carry out each maintenance programme when you are prompted to do so.

Rinsing the machine

You can start coffee system rinsing manually at any time.

Precondition: The start screen is displayed.

- ▶ Place a receptacle under the coffee spout.



- ▶ Press the > button for **approx. 2 seconds** to enter the JURA Cockpit.
- ▶ Press the ⚙️ button.
- ▶ Press the 'Rinse the coffee system' button to start the rinse operation.
'Machine is rinsing'
The operation stops automatically.

Inserting/changing the filter

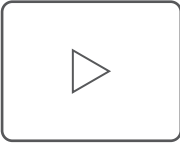

Tap, click or scan to watch
the video tutorial on YouTube



Once the filter cartridge stops working (depending on the water hardness setting), the W4 will prompt you to change the filter.

- i** Your W4 no longer has to be descaled if you are using the CLARIS Pro Smart+ filter cartridge.
- i** CLARIS Pro Smart+ filter cartridges are available from specialised dealers.

Precondition: The start screen is displayed. (Alternatively, the filter symbol  is displayed in red in the cockpit if the filter's capacity has been exhausted.)

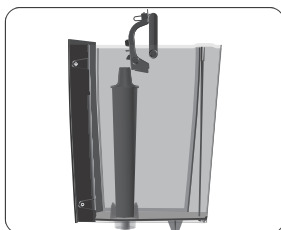

- ▶ Remove and empty the water tank.
- ▶ Open the filter holder and remove the **used** CLARIS Pro Smart+ filter cartridge.
- ▶ Insert a **new** CLARIS Pro Smart+ filter cartridge into the water tank, exerting slight pressure.



- ▶ Close the filter holder. It will click into place audibly.
- ▶ Fill the water tank with fresh, cold water and reinsert the tank.

- i** The machine automatically detects that you have just inserted the filter cartridge.

'Open switch'

- ▶ Turn the switch to the  position.
‘Filter is being rinsed’, water flows out of the hot-water spout.
‘Close switch’
- ▶ Turn the switch to the  position.

Cleaning the machine

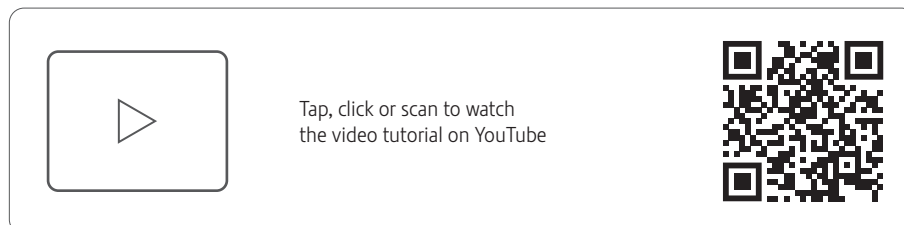

After 180 preparations or 80 switch-on rinses, the W4 will prompt you to clean it.

CAUTION

If the wrong cleaning agent is used, the machine could be damaged and/or traces could be left behind in the water.

- ▶ Use only original JURA maintenance products.

- i** The cleaning programme lasts approximately 20 minutes.
- i** Do not interrupt the cleaning programme. The quality of cleaning will be impaired if you do so.
- i** JURA cleaning tablets are available from specialised dealers.

Precondition: ‘Clean’ is displayed in the Cockpit.

- ▶ Fill the water tank.
- ▶ Press the  button for **approx. 2 seconds** to enter the JURA Cockpit.
- ▶ Press the ‘Clean’ button.
- ▶ Press the ‘Start’ button.
‘Empty grounds’
- ▶ Empty the drip tray and coffee grounds container and put them back into the machine.
‘Clean’
- ▶ Place a receptacle under the coffee spout.



- ▶ Press the ‘Next’ button.
Water flows out of the coffee spout.
The operation is interrupted, ‘Add cleaning tablet’.
- ▶ Open the cover of the filler funnel for ground coffee.
- ▶ Insert a JURA cleaning tablet into the filler funnel.

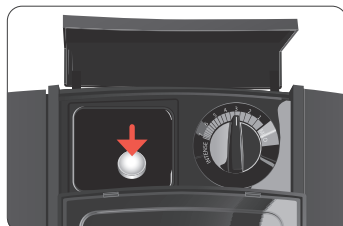

- ▶ Close the filler funnel cover.
- ▶ Press the ‘Next’ button.
Water flows out of the coffee spout several times.
‘Empty grounds’
- ▶ Empty the drip tray and coffee grounds container and put them back into the machine.

Descaling the machine

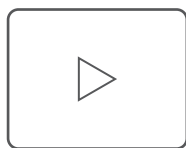

Tap, click or scan to watch the video tutorial on YouTube



The W4 builds up deposits of limescale over time and automatically prompts you to descale it when necessary. The degree of calcification depends on the hardness of your water.

i If you are using a CLARIS Pro Smart+ filter cartridge, you will not be prompted to descale.

⚠ CAUTION

If the descaling agent comes into contact with the skin or eyes, this can cause irritation.

- ▶ Avoid contact with the skin or eyes.
- ▶ Rinse off the descaling agent with clean water. Should you get any descaling agent in your eye, see a doctor.

CAUTION

If the wrong descaling agent is used, the machine could be damaged and/or traces could be left behind in the water.

- ▶ Use only original JURA maintenance products.

CAUTION

If the descaling operation is interrupted, there may be damage to the machine.

- ▶ Allow the descaling programme to run to the end.

CAUTION

If the descaling agent comes into contact with sensitive surfaces (e.g. marble), damage cannot be ruled out.

- ▶ Clean up any splashes immediately.

i The descaling programme lasts approximately 20 minutes.

i JURA descaling tablets are available from specialised dealers.

Precondition: 'Descale' is displayed in the Cockpit.

- ▶ Press the > button for **approx. 2 seconds** to enter the JURA Cockpit.
- ▶ Press the 'Descale' button.
- ▶ Press the 'Start' button.
'Empty drip tray'
- ▶ Empty the drip tray and coffee grounds container and put them back into the machine.
'Agent in tank'
- ▶ Remove and empty the water tank.
- ▶ Completely dissolve 3 JURA descaling tablets in a receptacle holding 600 ml of water. This may take several minutes.

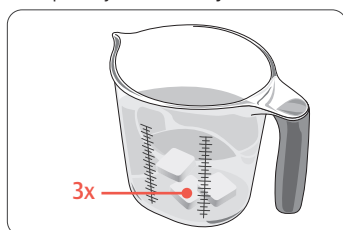

- ▶ Pour the solution into the **empty** water tank and insert it into the machine.
- ▶ Place a receptacle under the coffee spout.



- ▶ Press the 'Next' button.
'Open switch'
- ▶ Turn the switch to the ☰ position.
'Machine is being descaled', water flows out of the hot-water spout repeatedly.
'Close switch'
- ▶ Turn the switch to the ⊕ position.
The descaling operation is continued. Water flows directly into the drip tray.
'Empty drip tray'.
- ▶ Empty the drip tray and coffee grounds container and put them back into the machine.
'Rinse the water tank' / 'Fill water tank'
- ▶ Empty the receptacle and place it under the coffee spout again.



- ▶ Remove the water tank and rinse it thoroughly.
- ▶ Fill the water tank with fresh, cold water and reinsert the tank.
- ▶ Press the 'Next' button.
'Open switch'
- ▶ Turn the switch to the ☰ position.
'Machine is being descaled', water flows out of the hot-water spout repeatedly.
'Close switch'
- ▶ Turn the switch to the ⊕ position.
The descaling operation is continued.
'Empty drip tray'.
- ▶ Empty the drip tray and coffee grounds container and put them back into the machine.

i If the descaling operation stops unexpectedly, rinse the water tank thoroughly.

Descaling the water tank

Limescale deposits may form in the water tank. To ensure correct function of the machine, descale the water tank from time to time.

- ▶ Remove the water tank.
- ▶ If you use a CLARIS Pro Smart+ filter cartridge, remove this.
- ▶ Completely fill the water tank and dissolve 3 JURA descaling tablets in it.
- ▶ Leave the water tank with the descaling solution for several hours (e.g. overnight).
- ▶ Empty the water tank and rinse it thoroughly.
- ▶ If you use a CLARIS Pro Smart+ filter cartridge, insert this again.
- ▶ Fill the water tank with fresh, cold water and reinsert the tank.

Cleaning the bean container

Coffee beans may be covered with a slight oil film which remains on the walls of the bean container. These traces may negatively affect the coffee result. For this reason clean the bean container from time to time.

Precondition: 'Fill bean container' is displayed.

- ▶ Switch the machine off with the On/Off button ⏻.
- ▶ Remove the aroma preservation cover.
- ▶ Clean the bean container with a soft, dry cloth.
- ▶ Fill the bean container with coffee beans and close the aroma preservation cover.

8 Display messages

Messages on the start screen

Message	Cause/Result	Action
'Fill water tank'	The water tank is empty. You cannot prepare any products.	▸ Fill the water tank (see chapter 5 'Daily operation – Filling the water tank').
'Empty grounds' / 'Empty drip tray'	The coffee grounds container is full. / The drip tray is full. You cannot prepare any products.	▸ Empty the coffee grounds container and the drip tray (see chapter 5 'Daily operation – Maintenance actions').
'Drip tray not fitted'	The drip tray is not inserted correctly or is not inserted at all. You cannot prepare any products.	▸ Fit the drip tray.
'Fill bean container'	The bean container is empty. You cannot prepare any speciality coffees, but you can prepare hot water and milk.	▸ Fill the bean container (see chapter 3 'Preparing and using for the first time – Filling the bean container').
'Too hot'	The system is too hot to start a maintenance programme.	▸ Wait for several minutes until the system has cooled or prepare a speciality coffee or hot water.

Messages in the Cockpit

i If a maintenance programme is pending, this is indicated by an additional red circle on the start screen (●○○).

Message	Cause/Result	Action
The filter symbol  lights up red. 'Filter'	The filter cartridge is used up.	▸ Replace the CLARIS Pro Smart+ filter cartridge (see chapter 7 'Maintenance – Inserting/changing the filter').
'Clean'	The W4 is prompting you to clean it.	▸ Perform cleaning (see chapter 7 'Maintenance – Cleaning the machine').
'Descale'	The W4 is prompting you to descale it.	▸ Perform descaling (see chapter 7 'Maintenance – Descaling the machine').

9 Troubleshooting

Problem	Cause/Result	Action
Coffee only comes out in drips when it is being prepared.	The coffee is ground too finely and obstructs the system.	▸ Set the grinder to a coarser setting (see chapter 4 'Preparation – Adjusting the grinder').
	The water hardness may not have been correctly set.	▸ Perform descaling (see chapter 7 'Maintenance – Descaling the machine').
There is dry ground coffee behind the coffee grounds container.	The beans used are resulting in an above-average volume of ground coffee.	▸ Reduce the coffee strength or choose a finer grinder setting (see chapter 4 'Preparation – Adjusting the product settings').
Grinder is making a very loud noise.	There are foreign objects in the grinder.	▸ Contact customer support in your country (see chapter '13 JURA contact details / Legal information').
'ERROR 2' or 'ERROR 5' is displayed.	If the machine has been exposed to the cold for a long period of time, heating may be disabled for safety reasons.	▸ Warm the machine at room temperature.
Other 'ERROR' messages are displayed.	–	▸ Contact customer support in your country (see chapter '13 JURA contact details / Legal information').

i If you were unable to solve the problem, contact customer support in your country (see chapter '13 JURA contact details / Legal information').

10 Transport and environmentally friendly disposal

Transport / Emptying the system







Keep the packaging for your W4. It should be used to protect the machine during transport.

In order to protect the W4 from frost during transport, the system must be emptied.

Precondition: The start screen is displayed.

- ▶ Place a receptacle under the hot-water spout.



- ▶ Press the > button for **approx. 2 seconds** to enter the JURA Cockpit.
- ▶ Press the  button.
- ▶ Press the > button several times until the programme item 'Empty system' is displayed (page   .
- ▶ Press the 'Empty system' button.
- ▶ Remove and empty the water tank.
- ▶ **'Open switch'**
- ▶ Turn the switch to the  position.
Water flows out of the hot-water spout.
- ▶ **'Close switch'**
- ▶ Turn the switch to the  position.
Your W4 is switched off.



Disposal

Please dispose of old machines in an environmentally neutral way.



Old machines contain valuable, recyclable materials which should be recycled. Please therefore dispose of old machines via suitable collection systems.

11 Technical data

Voltage	220–240 V ~, 50 Hz
Power	1,450 W
Ambient conditions	Humidity max. 80% Ambient temperature 10 – 35 °C
Airborne noise emitted	$L_p < 70$ dB (A)
Conformity mark	 
Pump pressure	static, max. 15 bar
Holding capacity of water tank (without filter)	3 l
Holding capacity of bean container	500 g
Holding capacity of coffee grounds container	max. 25 portions
Cable length	approx. 1.1 m
Weight	approx. 10.4 kg
Dimensions (W × H × D)	29.5 × 44.4 × 44.6 cm
CLARIS filter cartridge Pro Smart+ (RFID technology)	Frequency band 13.56 MHz Max. transmission power < 1 mW
JURA Connector (Wi-Fi or Bluetooth connection)	Frequency band 2.4 GHz Max. transmission power < 100 mW
JURA type	779

Information for testers (repeat test in accordance with DIN VDE 0701-0702): The central grounding point (CGP) is located at the rear of the machine, to the left of the mains cable connection.

12 Index

A

- Addresses 19
- Adjusting the product settings 10
- Americano 8
- Aroma preservation cover
 - Bean container with aroma preservation cover 3

B

- Bean container
 - Bean container with aroma preservation cover 3
 - Cleaning 15
 - Filling 6
- Bus bar
 - Technical data 17
- Button
 - On/Off button 3

C

- Central grounding point 17
- Children 4
- CLARIS Pro Smart filter cartridge
 - Changing 12
 - Inserting 12
- Cleaning
 - Bean container 15
 - Machine 13
- Cockpit 7, 11, 12
- Coffee 8
- Coffee grounds container 3
- Coffee spout
 - Height-adjustable coffee spout 3
- Consistency of grind
 - Adjusting the grinder 10
 - Grinder adjustment switch 3
- Contact details 19
- Cover
 - Filler funnel for ground coffee 3
 - Water tank 3
- Cup grille 3
- Customer support 19

D

- Damage
 - Preventing damage 5
 - What to do in the event of damage 4
- Declaration of Conformity 19
- Descaling
 - Machine 14
 - Water tank 15
- Display 3
 - Cockpit 7
- Display messages 16
- Disposal 17
- Double product 8
- Drip tray 3
 - Insert 3

E

- Emptying the system 17
- Errors
 - Troubleshooting 16
- Espresso 8
- EU Declaration of Conformity 19

F

- Filler funnel
 - Filler funnel for ground coffee 3
- Filling
 - Bean container 6
 - Water tank 10
- Filter

- Changing 12
- Inserting 12
- First-time use 6

G

- Grinder adjustment switch 3
- Ground coffee 9
 - Measuring spoon for ground coffee 3
- Grounding point 17

H

- Height-adjustable coffee spout 3
- Hotline 19
- Hot water 9
- Hot water preparation
 - Switch for hot water preparation 3
- Hot-water spout 3

I

- Insert for drip tray 3
- Instant coffee
 - Ground coffee 9

J

- JURA
 - Contact details 19

L

- Lungo 8

M

- Machine
 - Cleaning 13
 - Descaling 14
 - Rinsing 12
 - Setting up 6
- Machine settings 11
- Mains cable 3
- Maintenance 12
- Maintenance actions 11
- Measuring spoon for ground coffee 3
- Messages, display 16

P

- Preparation 8
 - Americano 8
 - Coffee 8
 - Espresso 8
 - Ground coffee 9
 - Hot water 9
 - Lungo 8
- Problems
 - Troubleshooting 16
- Product settings
 - Adjusting 10
- Proper use 4

R

- RFID 17
- Rinsing
 - Machine 12

S

- Safety information 4
- Setting up
 - Setting up the machine 6
- Spout
 - Hot-water spout 3
- Switch for hot water preparation 3
- Switching off 10
- Switching on 10
- Symbol description 4

T

- Technical data 17

Tel 19
 Transport 17
 Troubleshooting 16

U

Use, first time 6
 Users 4

W

Water hardness
 Determining the water hardness 6
 Water tank 3
 Descaling 15
 Filling 10
 Wireless connection 6, 17

13 JURA contact details / Legal information

JURA Elektroapparate AG
 Kaffeeweltstrasse 10
 CH-4626 Niederbuchsiten
 Tel. +41 (0)62 38 98 233

- i** You can find additional contact details for your country at jura.com.
- i** If you need assistance with using your machine, you can find this at jura.com/service.
- i** Your opinion is important to us! Use the contact details at jura.com.

Directives

The machine complies with the following directives:

- 2006/42/EC – Machinery Directive
- 2014/30/EU – Electromagnetic Compatibility
- 2009/125/EC – Ecodesign Directive
- 2011/65/EU – RoHS Directive
- 2014/53/EU – Wireless Voltage Directive

A detailed EU Declaration of Conformity for your W4 can be found at jura.com/conformity.

Technical changes

We reserve the right to make technical changes. The diagrams used in these instructions for use are for illustration purposes only and do not represent the original colours of the machine. Some details of your W4 may vary.